Improving Performance of Arrays

Richard C. Jaeger, K4IQJ

Robert L. Schafer, KA4PKB

Auburn, AL

Dayton Hamvention, May 18, 2012

K4IQJ@mindspring.com

INTRODUCTION

- Introduction & Background
 - RDF Definition
 - Basic K9AY Loop Pair
 - Antenna/Array Comparisons
- Focus on Two-element Arrays
 - K9AY Array – Design & Simulation
 - Array Implementations
 - Filling in the Gaps (8-Way Switching)
 - Results
- Discussion / Observations

INTRODUCTION

Remote Installation



Tentec Omni VII

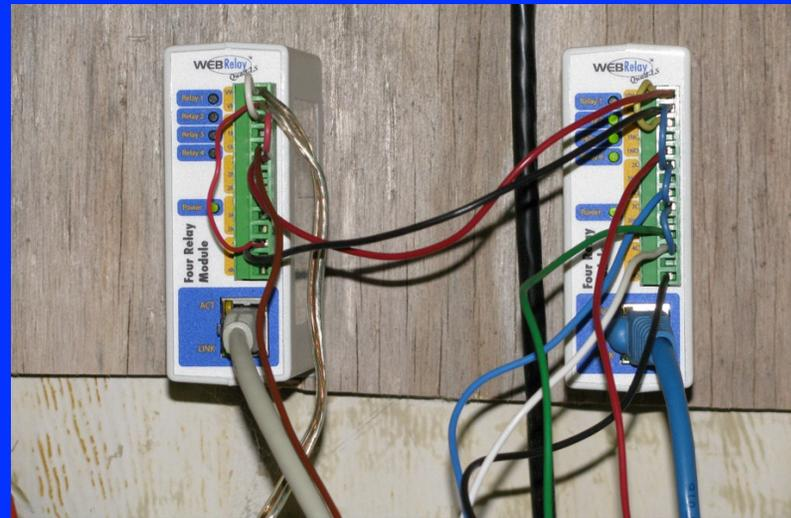

Control by Web Relays

Needed Antenna for Remote Antenna Site
Decided to Try BOG & Two-element Loop Arrays
“Quick & Easy”

INTRODUCTION

- Poor Ground Conditions
 - Very rocky with rock shelves and red clay
 - Ground conductivity: 2-3 mS/m
- Loops Seem Most Effective Receiving Antennas in My Locations
- Needed Antenna for Remote Antenna Site
 - Decided to try BOG & two-element loop arrays (Quick & Easy)
- This Presentation Concentrates on the Performance of Two-Element K9AY Arrays

INTRODUCTION

Two-Element Arrays

- Second Element Offers Significant RDF Increase
- As in a Yagi, the second element adds the most
- Straight-Forward Implementation
 - Hi impedance amplifiers/No matching transformers
 - Robust to both phase & amplitude errors
 - Loop direction switching required
- Potential Problems
 - Beam width narrows (98°)
 - RDF reduced by 2.5 dB at $\pm 45^\circ$ points
- Explore 8 Direction Switching

BACKGROUND

RDF: Receiving Directivity Factor

- Design Goal Here: Maximize RDF
- $RDF_{dB} = G_{for}(dB) - G_{avg}(dB)$
 - Noise generally comes in from all directions
 - RDF compares the main antenna lobe gain to the average gain over the whole hemisphere of the antenna
 - Attributed to W8JI

BACKGROUND

Reference Antenna – Short Vertical (20')

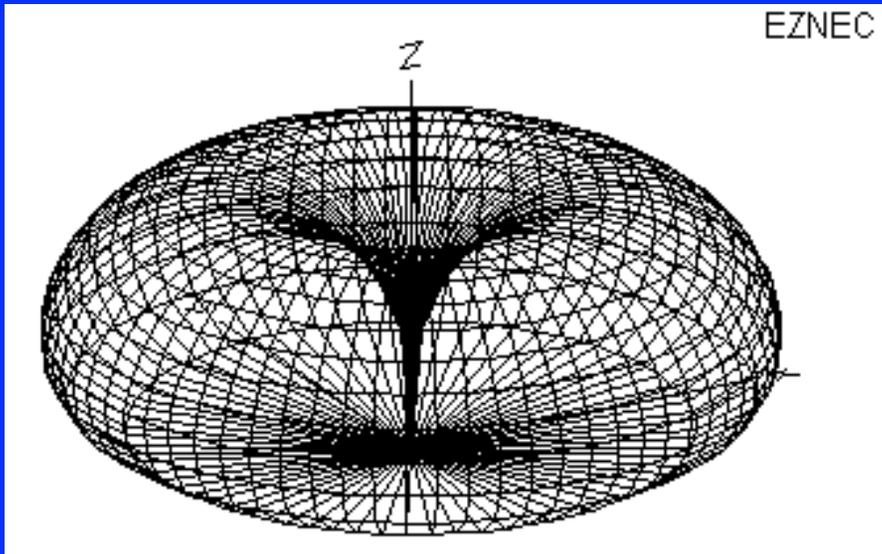

Forward Gain: 1.0 dBi

Average Gain: -3.9 dBi

RDF: 4.9 dB

Omni Directional

W/C F/B: 0 dB

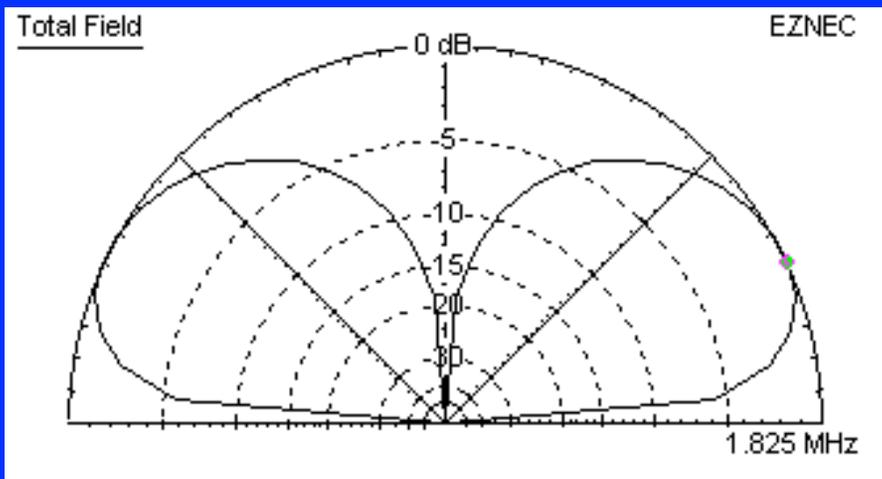

5/12/12

RCJ-8

BACKGROUND

Basic K9AY Loop

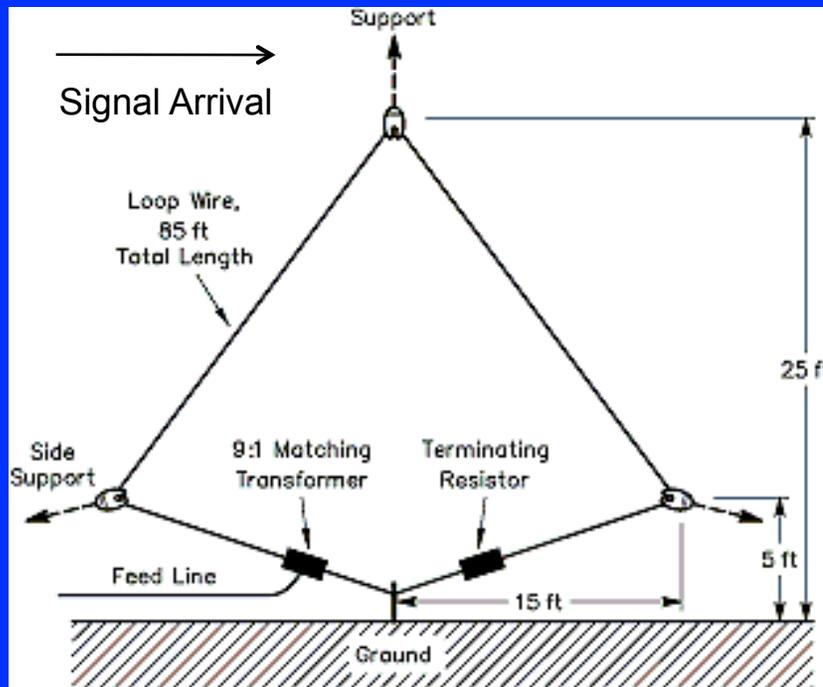

- 85' Triangular Loop
- 25' High, 30' Wide
- Resistive Termination
- Directional Antenna
 - Easily switched in 2 directions
 - 4 directions with an orthogonal pair of loops
- 9:1 Matching Transformer to Coax

Gary Breed, "The K9AY terminated loop – A compact, directional receiving antenna," QST, vol. 81, no. 9, pp. 43-46, September 1997.

BACKGROUND

Single K9AY Loop Characteristics

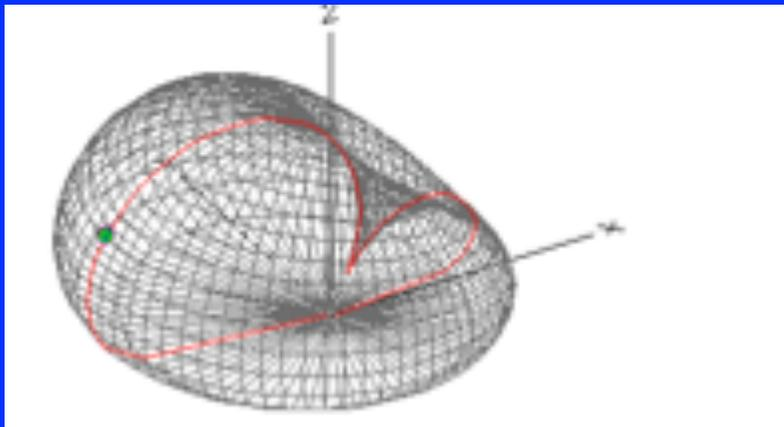
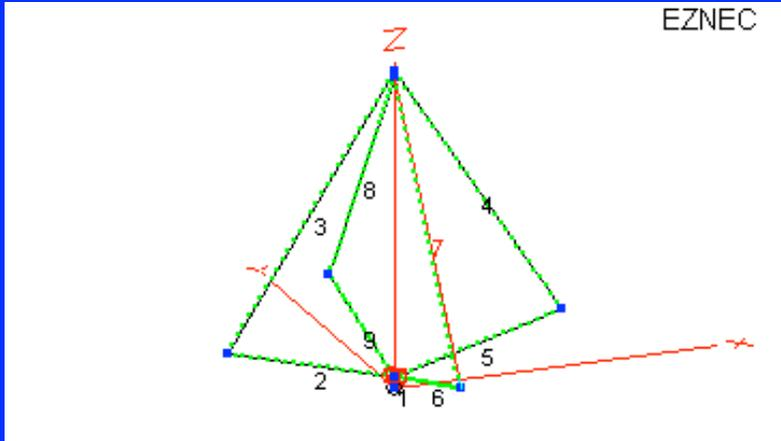

- 2.5 dB RDF Increase Over Vertical
- Broadband (Flat to 20 MHz)
- Gain -25 dBi (<< Vertical)
- Directional Antenna
 - End-fire (In plane of the loop) opposite termination
 - Similar to a cardioid pattern
 - Reduced response in rear direction

BACKGROUND

Single K9AY Loop Characteristics

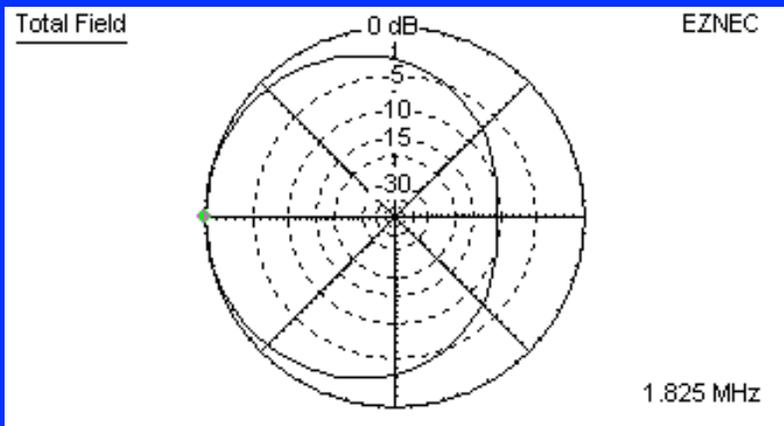
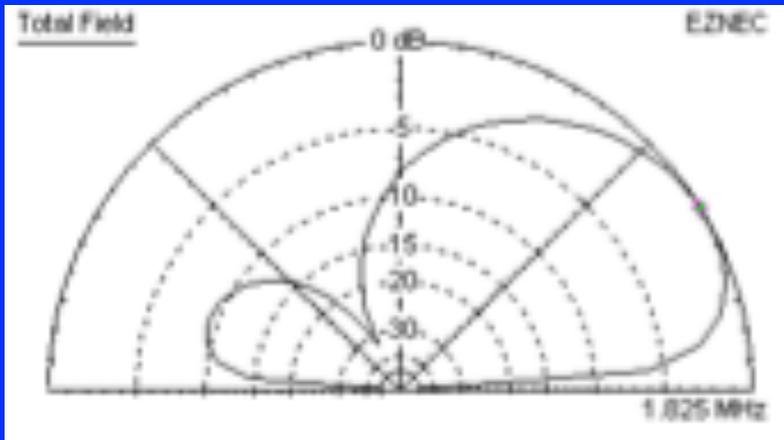

30° Elevation

Forward Gain: -25.4 dBi

Average Gain: -32.9 dBi

RDF: 7.5 dB

Beamwidth: 167°

Take Off Angle: 32°

Rear - Deep High Angle Null

W/C F/B: 9.5 dB

Down 0.8 dB at ±45° points

BACKGROUND

Multi-Element Endfire Arrays

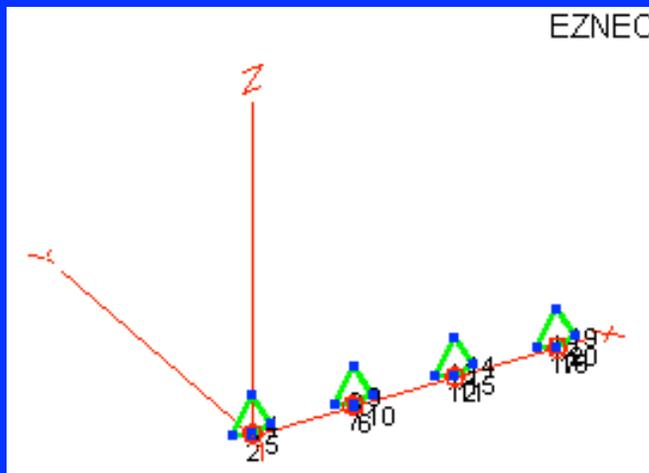
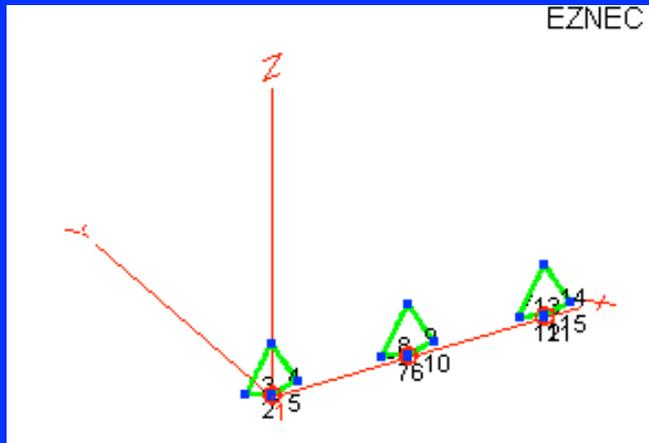

- 2-3-4 Elements or More
- “Lossy” Antennas
 - Resistive termination
 - Essentially no mutual coupling
- Array Output Decreases as number of Elements Increases
 - (-24 dBi) → (-40 dBi)

K9AY ARRAYS

RDF Comparisons

Table I - Comparison of End-Fire Arrays with a Single Loop - 80' spacing

	160M RDF	80M RDF	160M / 80M - Crossfire Phasing
Short Vertical	4.9 dB	4.9 dB	---
Single Loop	7.4 dB	7.4 dB	---
2-Element Array (1-1)	10.5 dB	10.0 dB	-200° / -220°
3-Element Array (1-1.84-1)	12.5 dB	11.3 dB	0, -200°, -400° / 0, -220°, -440°
4-Element Array (1-2.6-2.6-1)	14.6 dB	13.8 dB	0, -195°, -390°, -585°

Focus Now on 2-EL Arrays

Two-Element End-Fire Array

Array Optimization - 160 M / 1.825 MHz

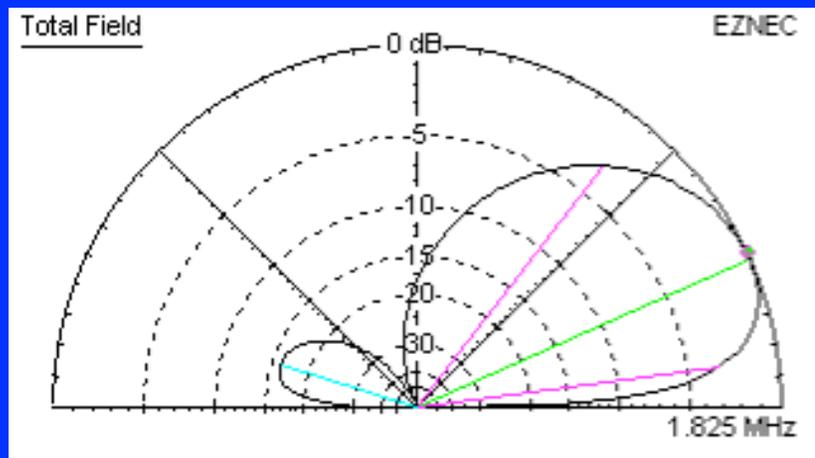
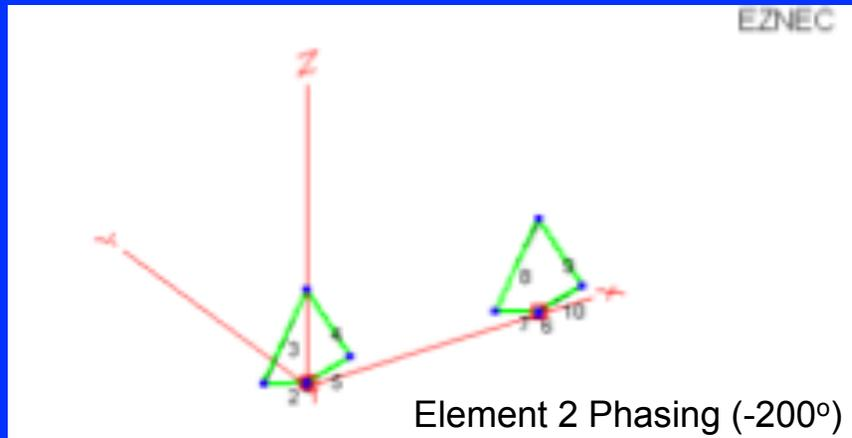

- Two-Element Array
 - Equal amplitudes
 - Single phasing line
 - Rear element lags front element
- Gain: -25.7 dBi
- RDF: 10.5 dB (+3 dB)
- Beamwidth: 96°
- W/C F/B: 16.6 dB
- Take Off Angle: 25°

2-ELEMENT ARRAY OPTIMIZATION

Performance vs. Spacing

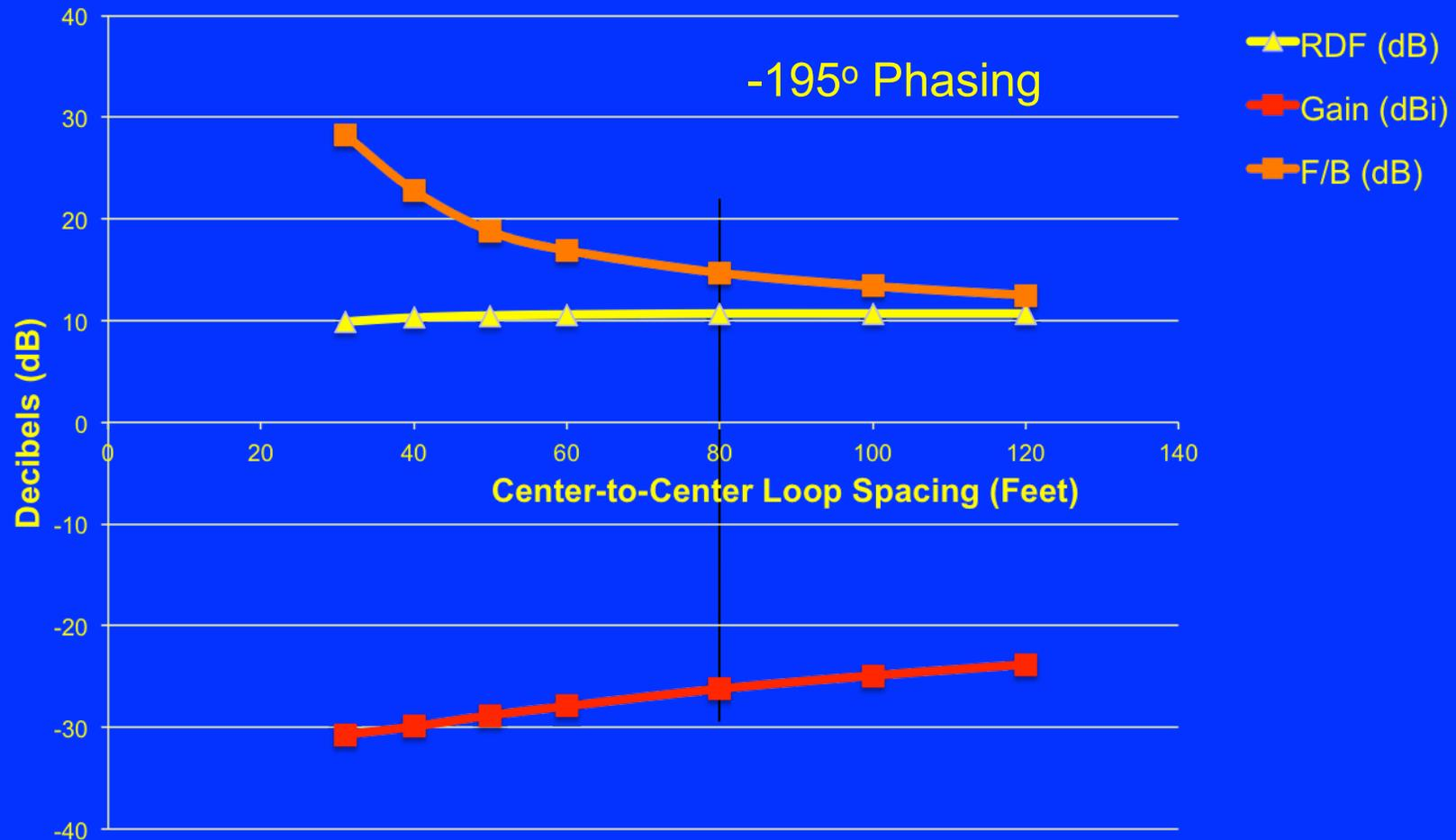

2-ELEMENT ARRAY OPTIMIZATION

RDF & F/B vs. Phasing for 80' Spacing

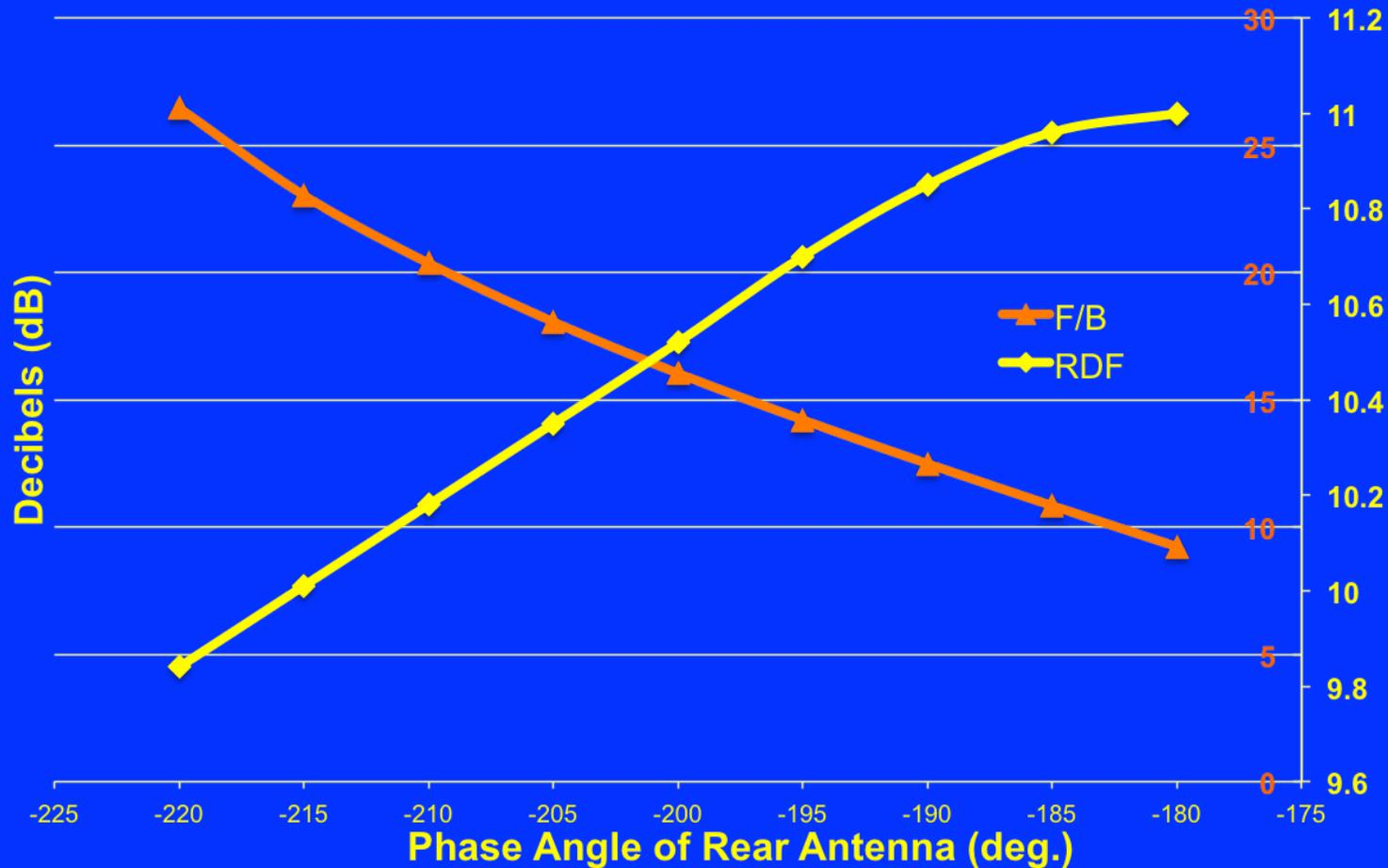

2-ELEMENT ARRAY OPTIMIZATION

Performance vs. Back Element Amplitude

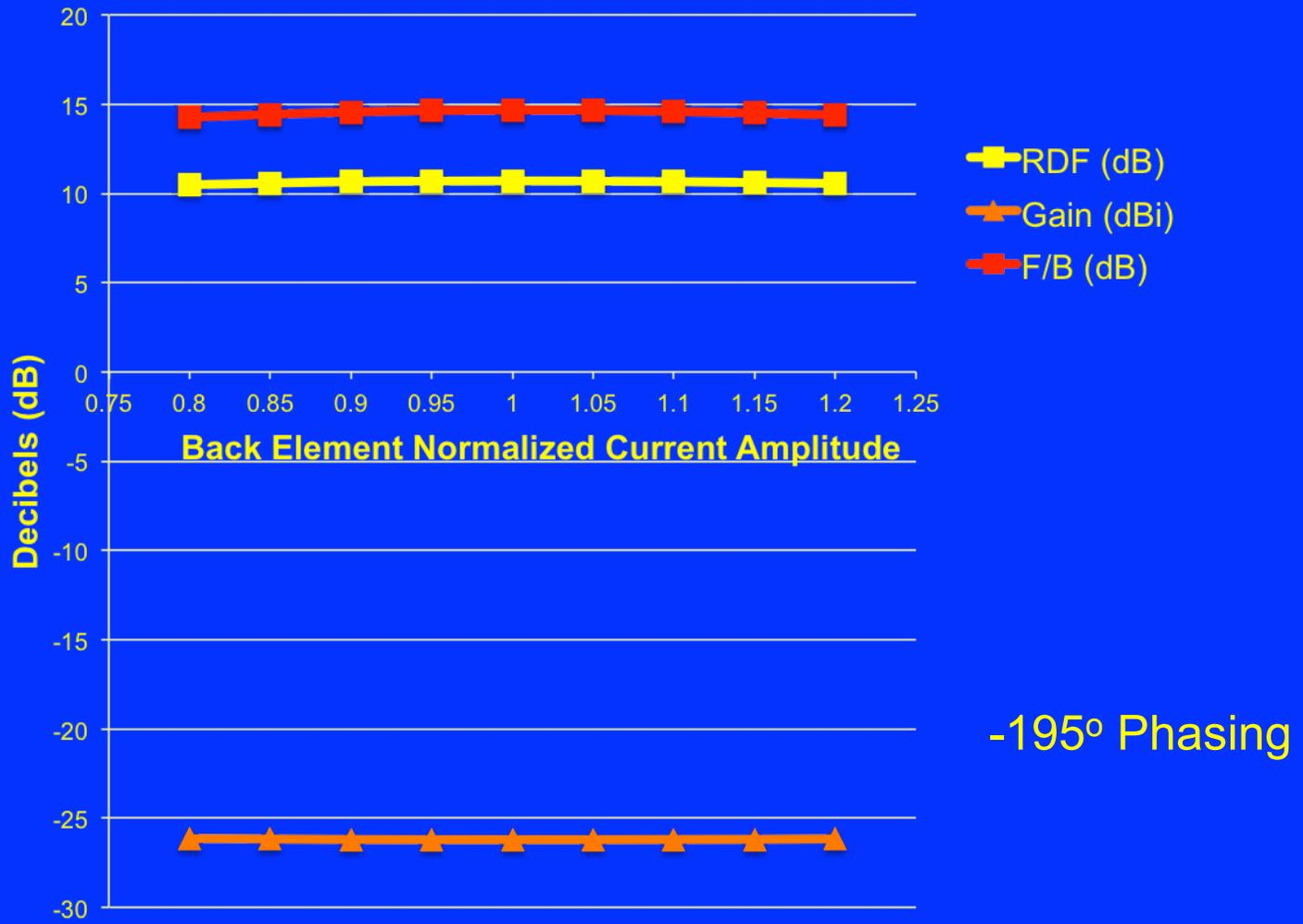

-195° Phasing

ARRAY IMPLEMENTATION

Possible Array Layouts

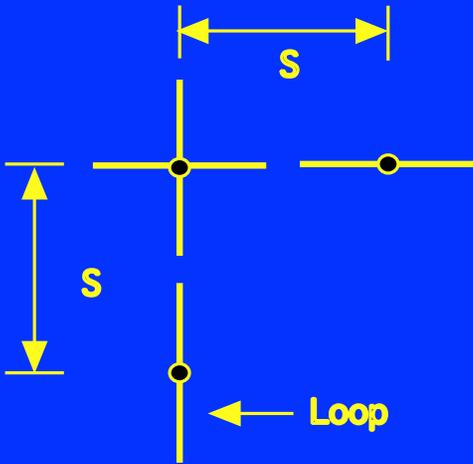

“L” - Crossed Pair
at Corner

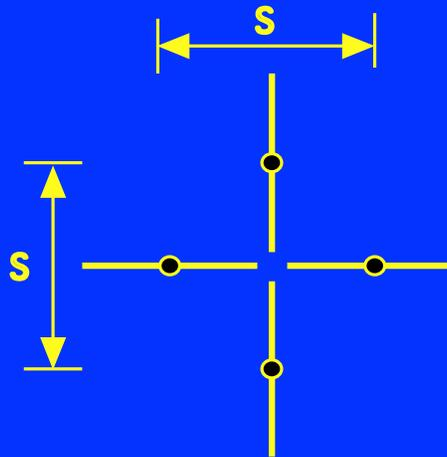

Symmetrical
Array

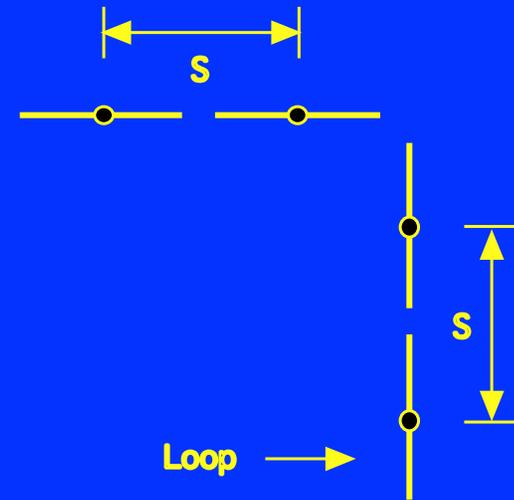

“L” - Separated
Arrays

(S: 30-120 ft)

ARRAY IMPLEMENTATION

L-Shaped Layout – N/S & E/W Arrays

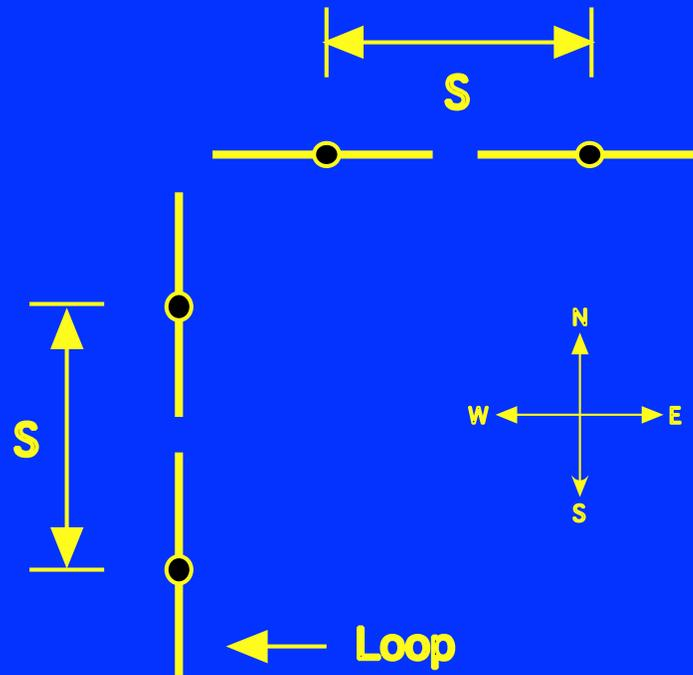

- Along Border of Large Field
- Field is in Use Much of the Year
- Keeps Antennas Out of Field
- $S = 80'$
- Phase: -195°

ARRAY IMPLEMENTATION

Cross-Fire Feed (W8JI)

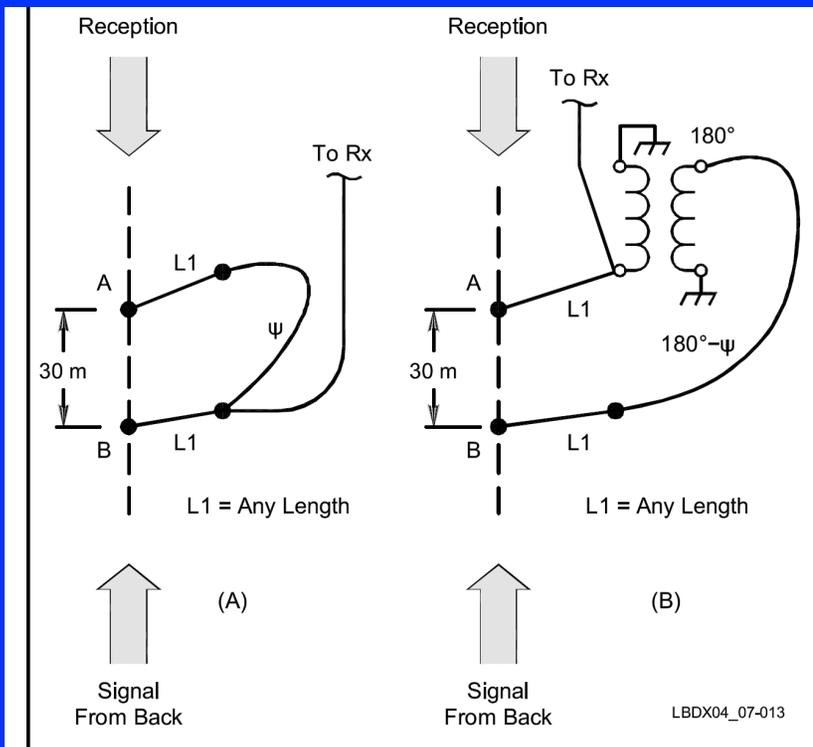

Fig 7-13 — Two ways of feeding the 2-element end-fire array. The system on the left is good for one frequency, while the system on the right can be used with the same length of phasing cable over a very wide range of frequencies (easily two bands).

Phase Lags Exceed 180°
e.g. Phase lags 195°

John Devoldere, *ON4UN's Low-Band Dxing, Fifth Edition*, ARRL, Newington, CT: 2011, p. 7-19.

ARRAY IMPLEMENTATION

0° Hybrid Combiner

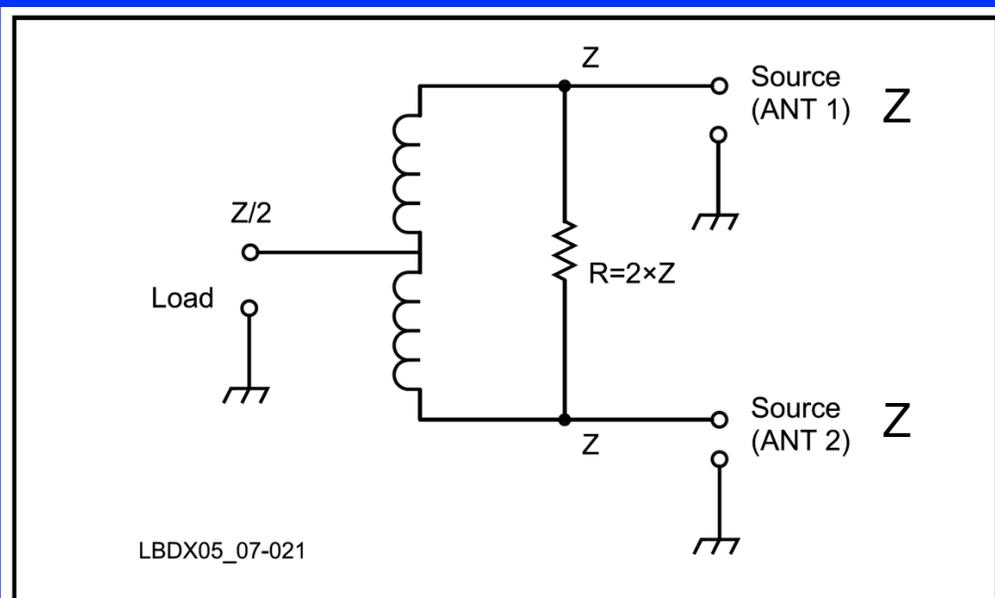

Fig 7-21 — Simplified schematic diagram of the 0° hybrid combiner.

Provides Matched Termination (Z) for Both Antennas

Excellent Isolation Between Antennas

$Z = 75 \text{ Ohms}$

John Devoldere, *ON4UN's Low-Band Dxing, Fifth Edition*, ARRL, Newington, CT: 2011, p. 7-22.

ARRAY IMPLEMENTATION

Coax Phasing Lines

Phase Shift of Phasing Lines – Calculated from Open Circuit Measurements				
	N/S 1.825MHz	N/S 3.505MHz	E/W 1.825MHz	E/W 3.505MHz
Phasing Line	19.0 ft / 15.2°	29.1°	15.2°	29.1°

- Nominal Phase Shift for 160M: $195^\circ - 180^\circ = 15^\circ$
- Phase Shift Expected on 80M: 28.8°
 - $15.2^\circ * (3.505/1.828) = 29.1^\circ$
- Network or Antenna Analyzer
 - Measure the resonant frequency or fault of open-circuited line
 - Calculate phase by frequency scaling

ARRAY IMPLEMENTATION

Loop Antennas – N/S & E/W Arrays



N/S Array



E/W Array

Fiberglass Support Poles (Max-Gain Systems)
Control Cables and Coax in PVC on Ground

ARRAY IMPLEMENTATION

Loop Termination and Switching

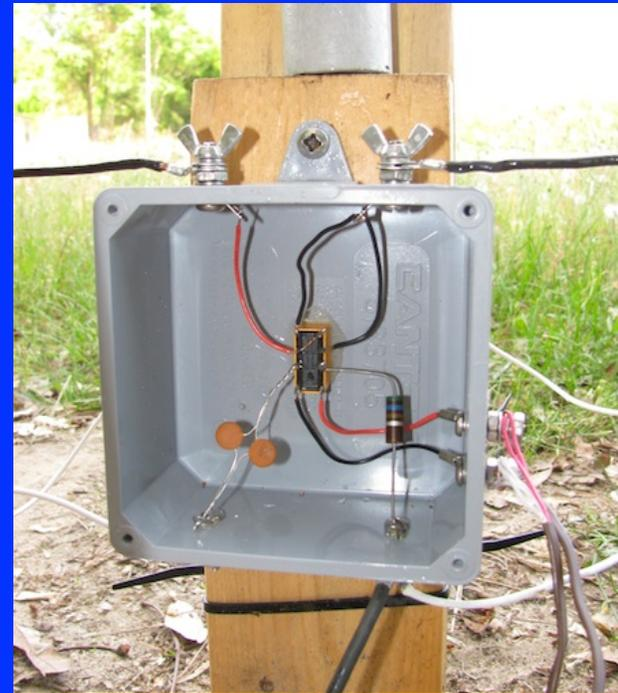
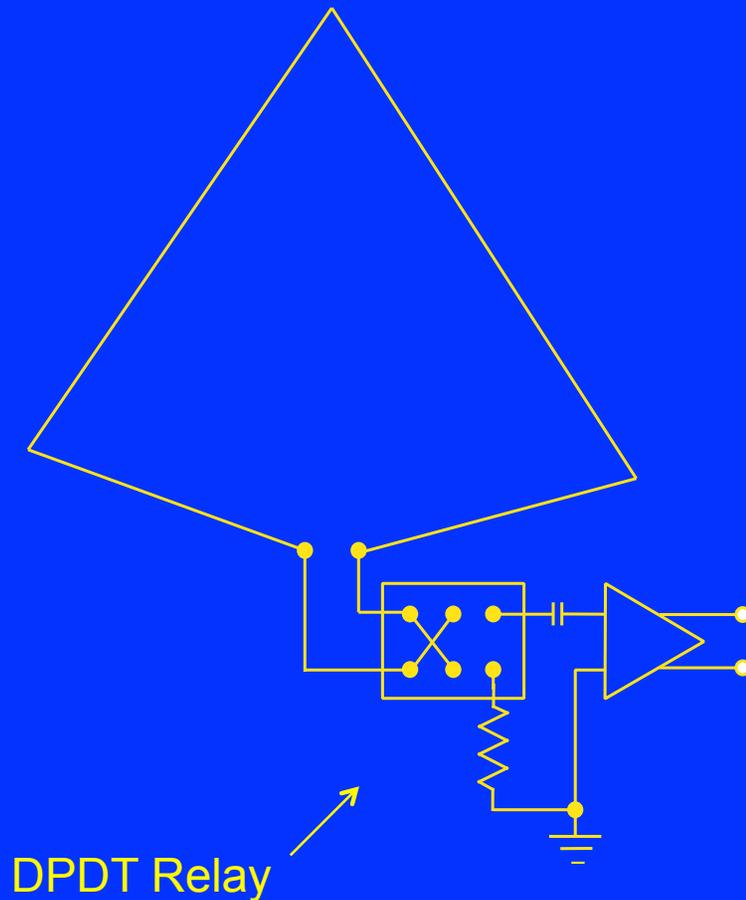

- DPDT Relay, 510-Ω Termination
- ac Coupled
- Water Tight Box (Lowe's)
- All Stainless Steel Hardware

ARRAY IMPLEMENTATION

Loop Support and Array Control



Loop Support, Direction Control Box, Hi-Z Amplifier

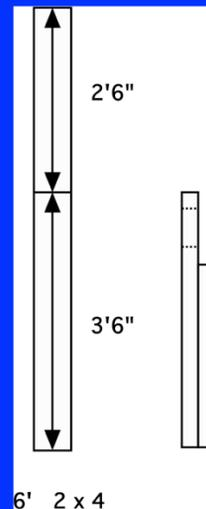

- Loops as Identical as Possible
- High Impedance Amplifiers
 - (Hi-Z Plus 6)
- ac Coupled (loop dc short)
- Single 510- Ω Termination
- Flooded RG-6 Coax
- DPDT Relay Switching
- A 3' Ground Stake at Loop Center
- Four 20' Radials Under Each Loop (45° relative to loop)

RESULTS

Experimental Setup

- Array Solutions VNA 2180 (50 Ω)
- Port A drives 50 Ω coax with 50- Ω termination at Input of Loop Switches (loop removed)
- 75 Ω coax from controller to VNA
- 75 Ω - 50 Ω Pad at input to VNA Port B
- Measurements repeatable to within 0.3 dB and less than 0.5°



RESULTS

Array Characterization



Set Up Ready for Measurements on the Arrays

RESULTS

Measurements

Table IV - Amplifiers + Controller				
Normalized Gain and Phase Matching				
1.827 MHz Results				
Loop	N/S Gain	N/S Phase	E/W Gain	E/W Phase
Front	-0.254 dB	0° (ref)	+0.457 dB	0° (ref)
Back	-0.375 dB	-195.4°	+0.171 dB	-193.7°
3.505 MHz Results				
Loop	N/S Gain	N/S Phase	E/W Gain	E/W Phase
Front	-0.331 dB	0° (ref)	+0.365 dB	0
Back	-0.336 dB	-205.2	+0.302 dB	-206.0

Note: Cross-fire phasing line on 160 & 80 M

(± 0.4 dB ≈ ± 5%)

RESULTS

Final Simulations - 160 M

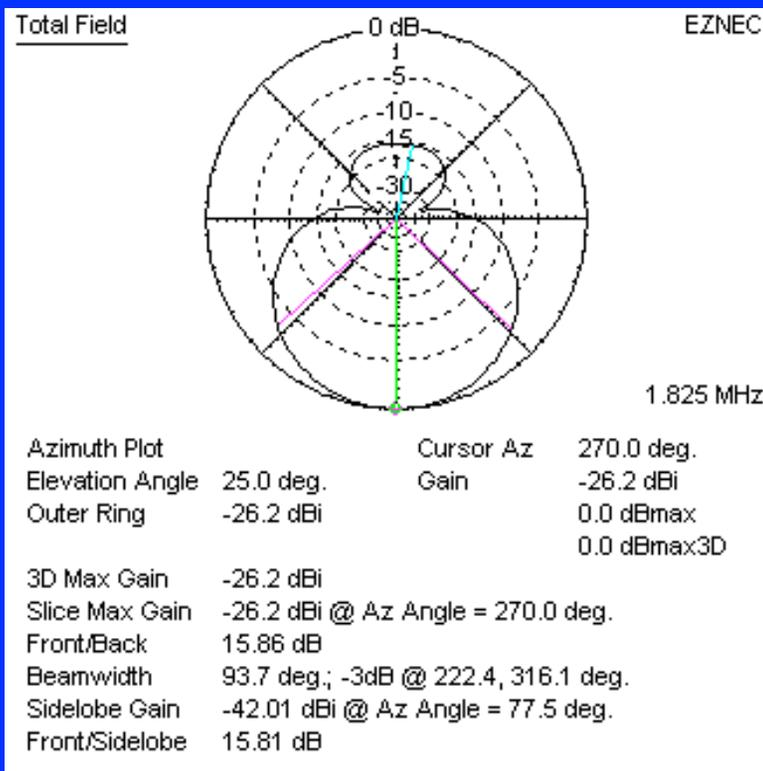

RDF 10.7 dB
Gain -26.2 dBi
F/B 15.8 dB

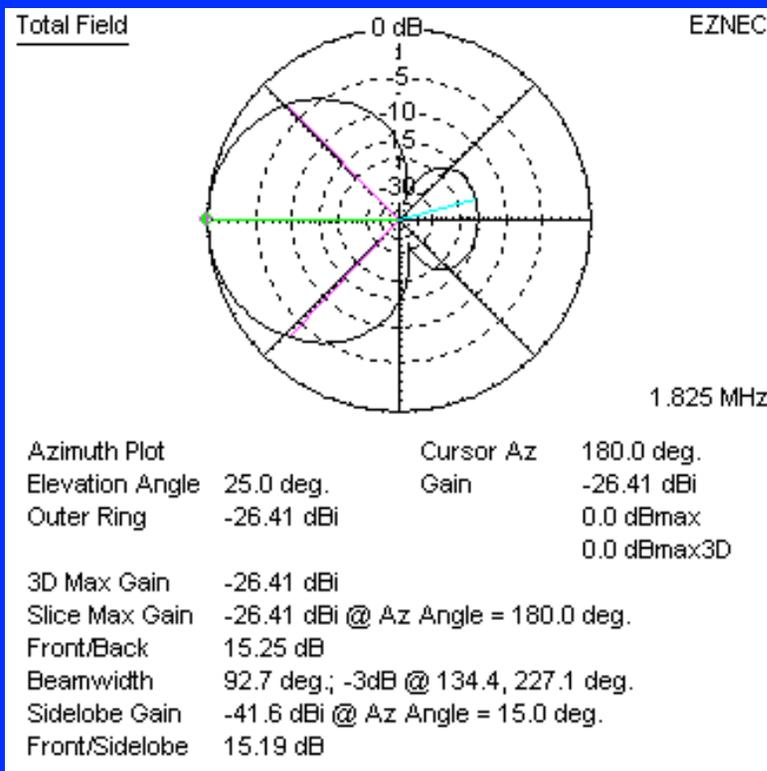

RDF 10.7 dB
Gain -26.4 dBi
F/B 15.2 dB

RESULTS

Final Simulations - 80 M

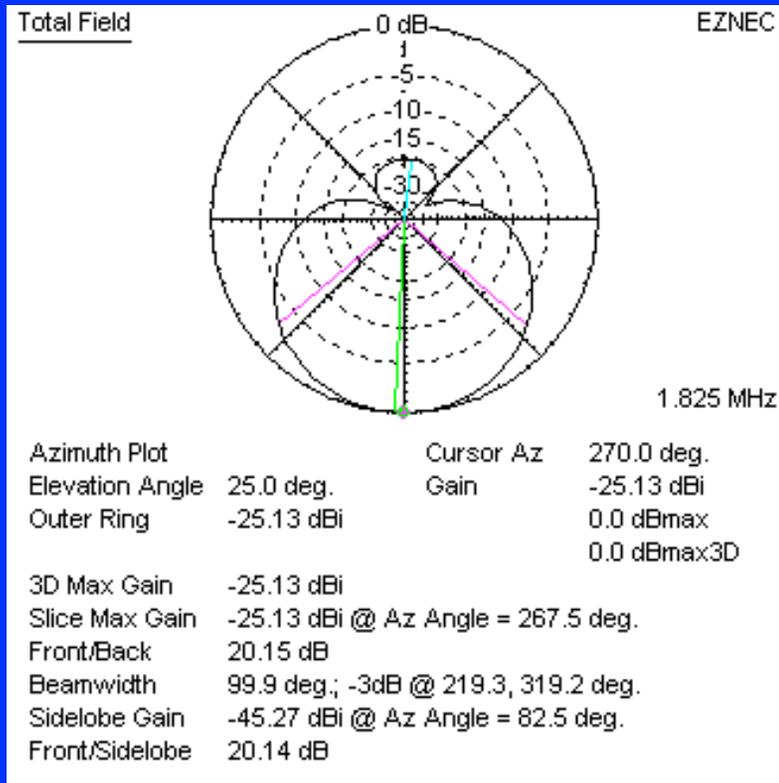

RDF 10.3 dB
Gain -25.1 dBi
F/B 19.2 dB

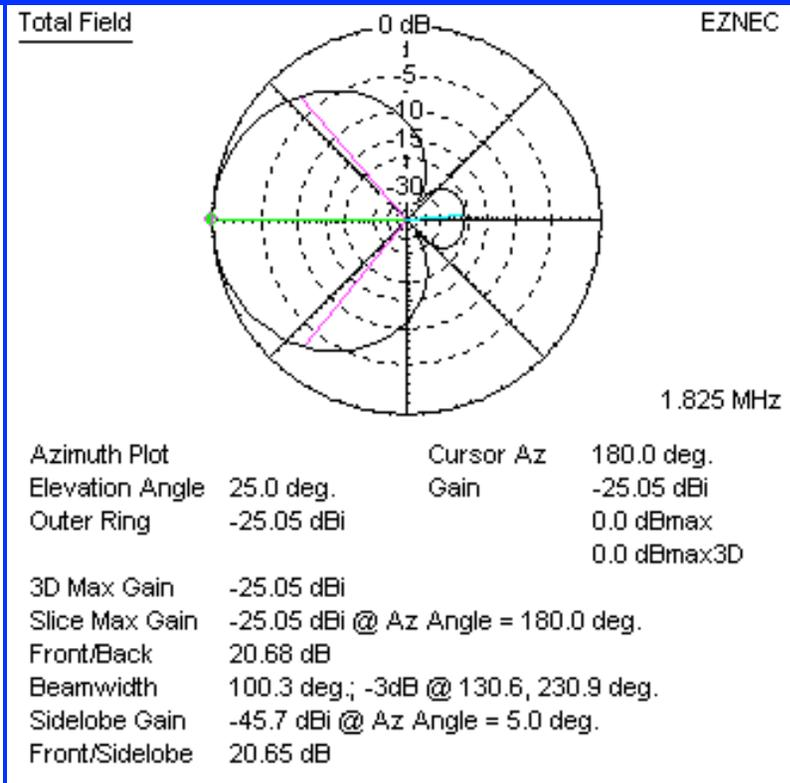

RDF 10.3 dB
Gain -25.1 dBi
F/B 19.6 dB

Two-Element Array

4-Way Switching Limitation

RDF decreases to 8 dB at $\pm 45^\circ$ Points

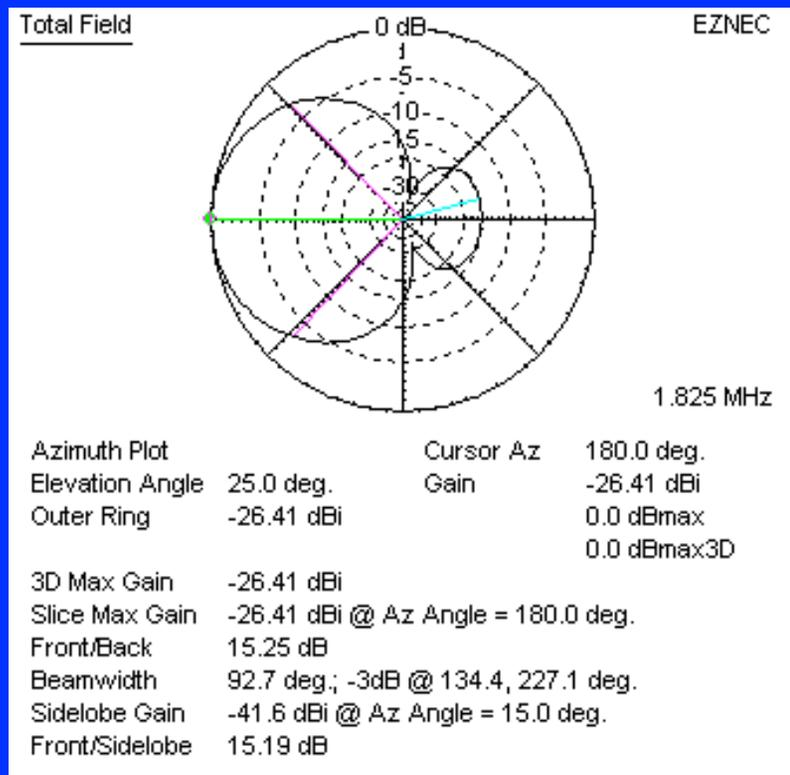

Array Pointed West

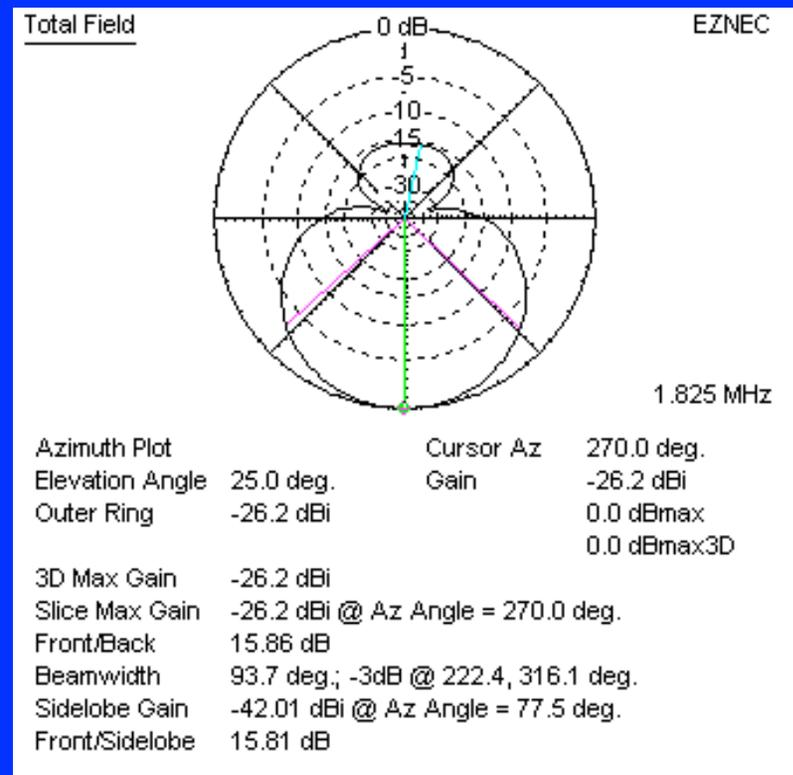

Array Pointed South

Two-Element Array

4-Way Switching Limitation

- Multi-Element Arrays Have Narrow Beam Widths
- Two-Element RDF
 - 10.7 dB in primary directions
 - RDF decreases to 8 dB at $\pm 45^\circ$ points
 - Only slightly better than single loop
- Fill in the Gaps
 - Add two more arrays for $\pm 45^\circ$ directions
 - Combine patterns of two N/S & E/W arrays

AZIMUTH PLOTS

8-Way Switching by Combining Patterns

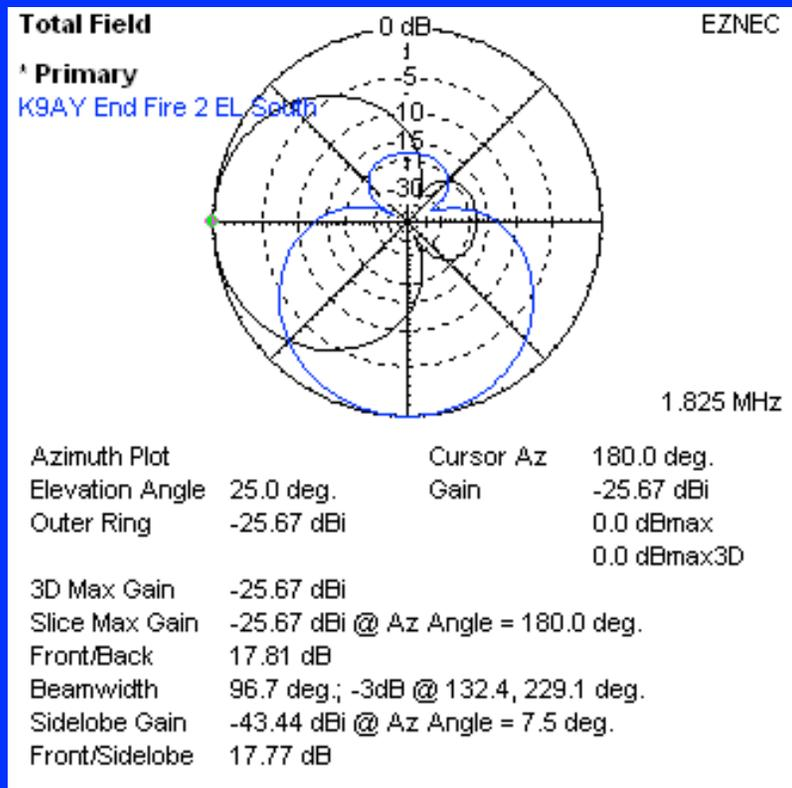

Arrays Pointed
South and West

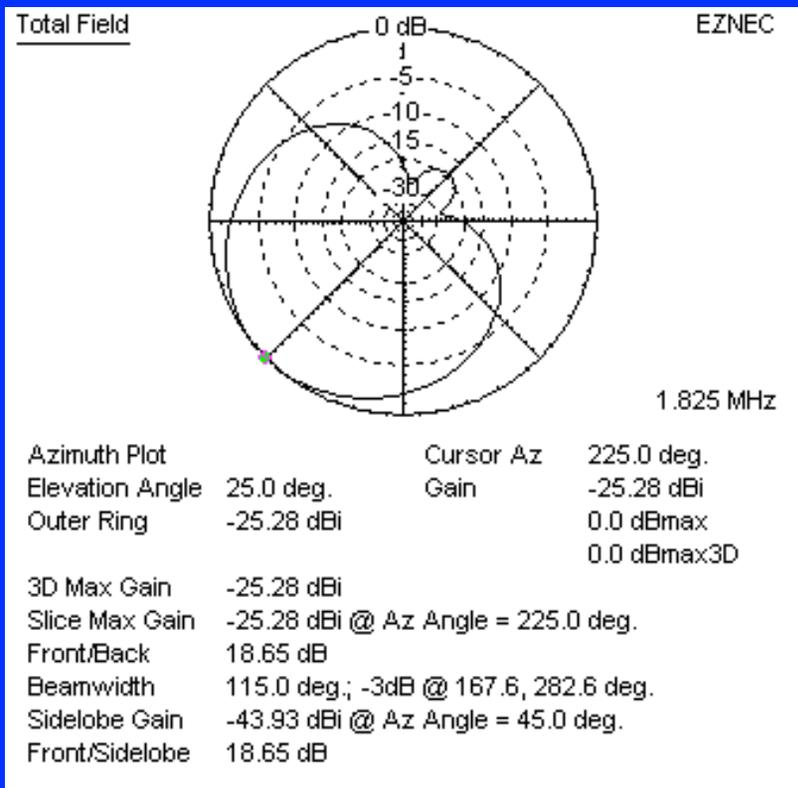

Array Pointed
South-West

Two-Element Array

8-Way Switching (-195° phasing)

- RDF
 - 10.7 dB in 4 Primary Directions
 - 9.7 dB at 45° Points
 - Gain Actually Somewhat Larger (+0.3 dB) in 45° Directions

ARRAY IMPLEMENTATION

Loop Combining & Switching

Array Connection and Direction								
	N	NE	E	SE	S	SW	W	NW
N/S On	On	On	Off	On	On	On	Off	On
N/S Dir.	N	N	X	S	S	S	X	N
E/W On	Off	On	On	On	Off	On	On	On
E/W Dir.	X	E	E	E	X	W	W	W

X = "Don't Care"

ARRAY IMPLEMENTATION

Loop Combining & Switching (Binary)

Array Connection and Direction (Binary)								
	N	NE	E	SE	S	SW	W	NW
ABC	000	001	010	011	100	101	110	111
N/ SOn	1	1	0	1	1	1	0	1
N/ SRev	0	0	X	1	1	1	X	0
E/ W On	0	1	1	1	0	1	1	1
E/ W Rev	X	0	0	0	X	1	1	1

1 = Yes
0 = No

$$NSON = \bar{B} + C$$

$$NSREV = A \oplus B$$

$$EWON = B + C$$

$$EWREV = A$$

ARRAY IMPLEMENTATION

System Design

- 8-Way Controller Designed & Built
- Combiner – Spare DXE 4 Square Controller (Short Cut)
 - Front elements into 1 & 3
 - Back elements into 2 & 4
 - Zero long delay / 15° short delays
- Hi-Z Plus 6 Amplifiers
 - 500 Ω antennas connected directly to amplifier inputs
- Must Switch Loop Terminations with Controller Direction
- “Common-mode” Chokes
 - (The Wireman)

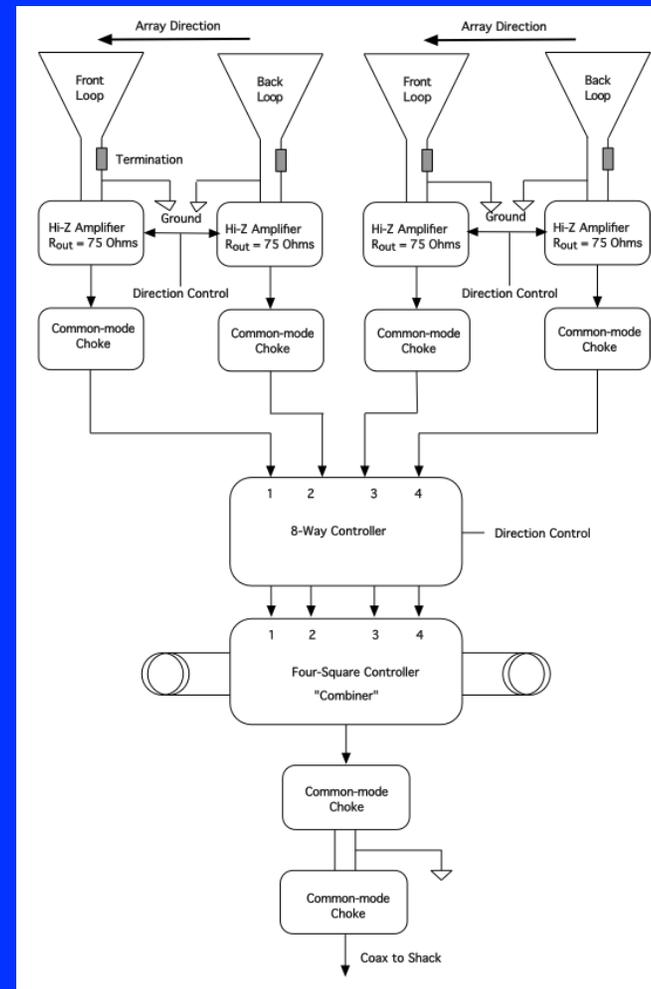

ARRAY IMPLEMENTATION

Array Direction Control / Array Combiner

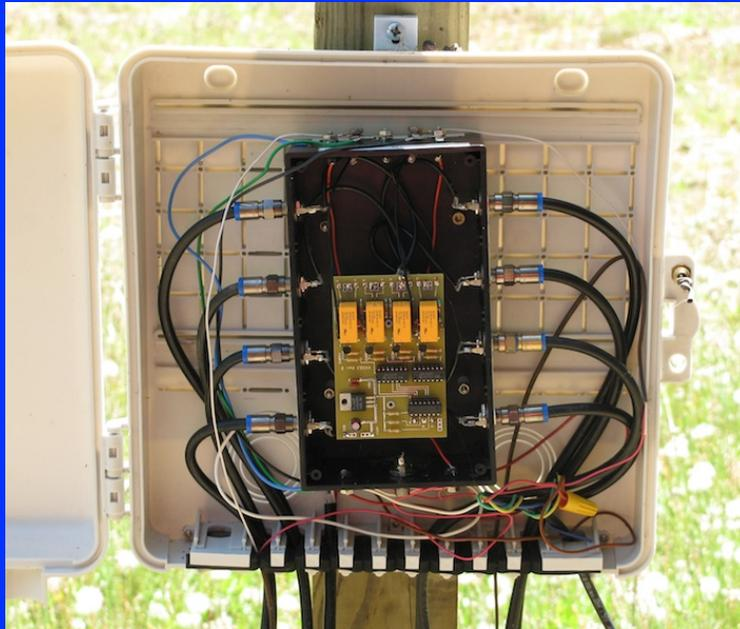

Direction Control Board

DXE Controller used as
Array Combiner



RESULTS

Final Simulations - 160 M

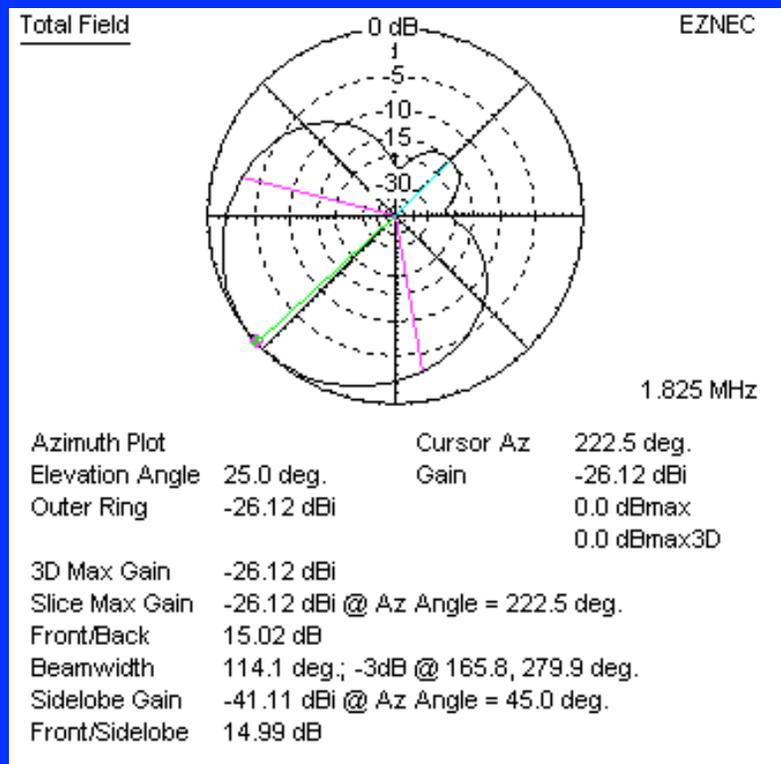
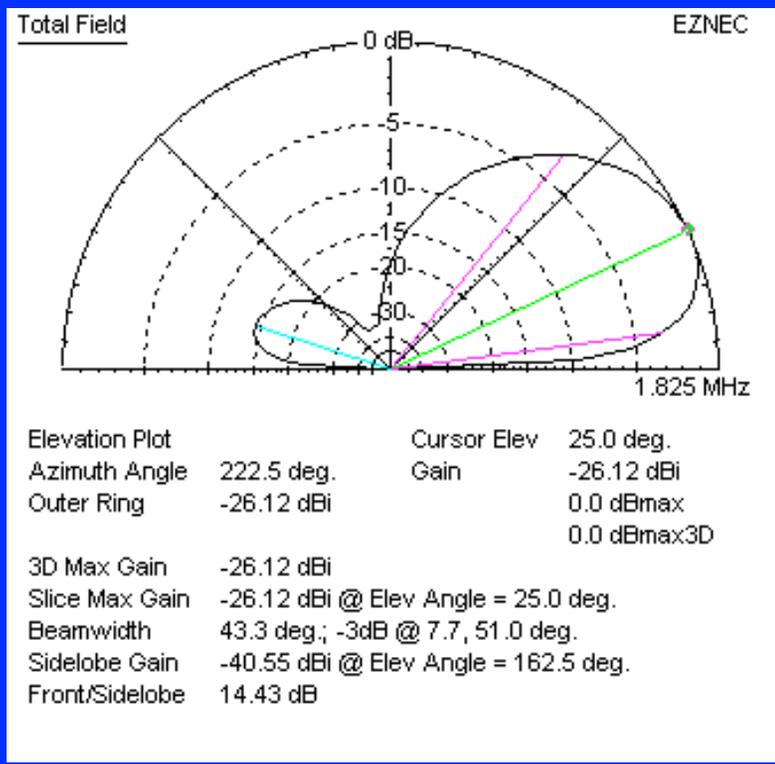

RDF 9.7 dB

Gain -26.1 dBi

F/B 14.4 dB

RESULTS

Final Simulations - 80 M

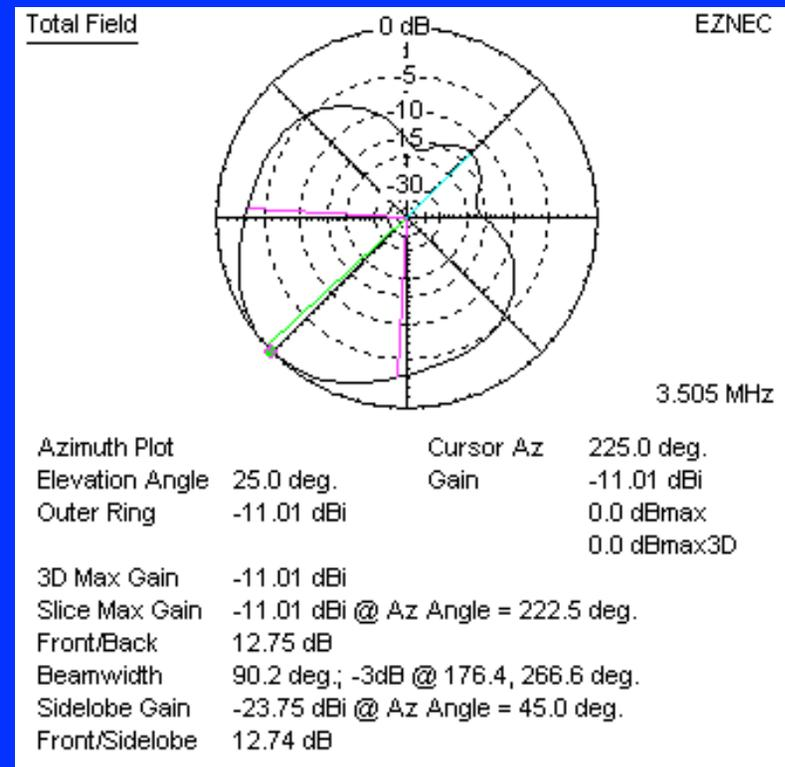
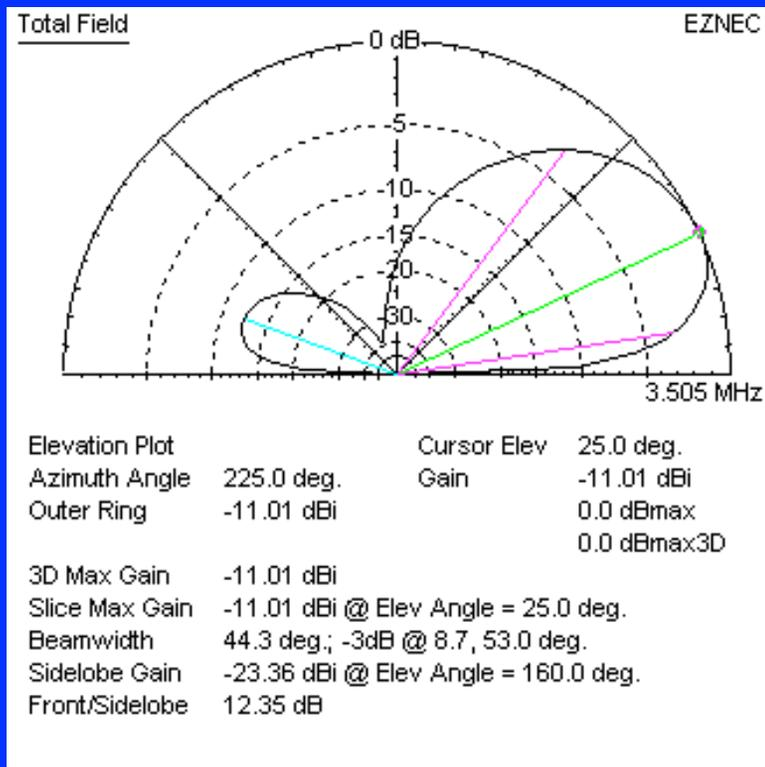

RDF 9.4 dB

Gain -11.0 dBi

F/B 12.4 dB

RESULTS

The Bottom Line

- Primary Array at Remote Receiver Site
- Testing
 - 1.6-1.8 MHz AM broadcast stations
 - 2.5 & 5 MHz WWV
 - 2.31 & 2.35 MHz Australian BC stations
 - 160M & 80M DX signals
- 8 Directions Readily Apparent
- 7O6T (Gone the Best Night – Of Course!)
 - 80 M
 - Solid copy NE on 5/6/12 and 5/8/12; SSb copy 5/11
 - Good copy on 5/7 (except for nearby storm qrn)
 - Marginal copy N & E
 - 160 M
 - No TB Copy on Any Antenna (as 5/12/12)!

RESULTS

The Bottom Line (cont.)

- Similar Technique Being Used At Home QTH with Pair of Three-Element Arrays
- Should have Used Gray Code
- Will Probably Reduce Spacing
- 50-ft Array with Crossfire Feed Maintains Pattern on 40 M (9 dB RDF)
- 500' BOG Comparison (Not Done)
 - Chewed up by “critters”
 - A 60' BOG doesn't work nearly as well as the 500' version
- Wellbrook K9AY Phased Array
 - www.wellbrook.uk.com/K9AYphasedarray.html

REFERENCES

1. Gary Breed, "The K9AY terminated loop – A compact, directional receiving antenna," QST, vol. 81, no. 9, pp. 43-46, September 1997.
2. Gary Breed, K9AY, "Arrays of K9AY Loops: "Medium-sized" low band RX antenna solutions," Sept. 15, 2007. <http://www.aytechnologies.com>
3. John Devoldere, *ON4UN's Low-Band DXing, Fourth & Fifth Editions*, ARRL, Newington, CT: 2005 & 2011.
4. Dallas Lankford, <http://groups.yahoo.com/group/thedallasfiles>
5. <http://www.fcc.gov/mb/audio/m3/index.html>
6. Hi-Z Antennas 4-Square, <http://www.hizantennas.com>
7. DX Engineering 4-Square, <http://www.dxengineering.com>
8. Max-Gain Systems, <http://www.mgs4u.com>
9. The Wireman, <http://www.thewireman.com>
10. Richard C. Jaeger, K4IQJ "Multi-Element End-fire Arrays of K9AY Loops," expanded version of 2011 Dayton presentation, May 15, 2011, available at

-
- THANK YOU FOR YOUR ATTENTION
 - QUESTIONS?

k4iqj@mindspring.com

www.k4iqj.com